

# Izdelava VF vezij na prototipnih ploščicah

Marko Cebokli S57UUU

RIS 2016 Ljubljana

# Kaksna prototipna ploščica je primerna za VF?

Spodaj:

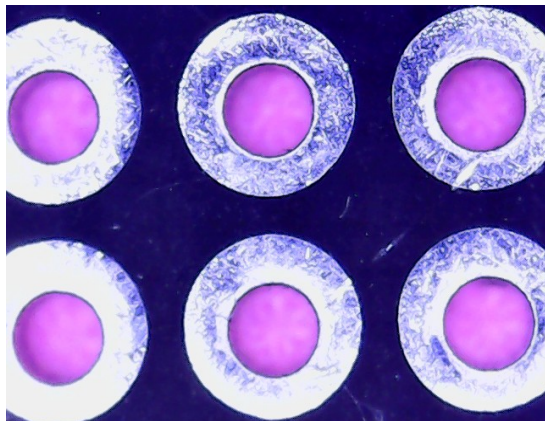

Zgoraj:



- luknje so 1mm (pred metalizacijo) raster 2.54 x 2.54, metalizirane
- zgoraj cela masa, 1.9mm brez bakra okrog lukenj, **nic padov**
- spodaj padi 2.23 mm
- material FR4 1.5mm
- baker 35um, pocinjen
- velikost platke 100x160, luknje do roba

Padi na zgornji strani poslabšajo lastnosti!

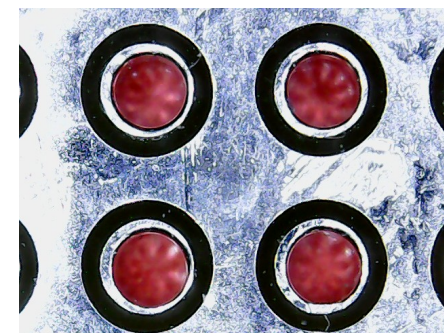

Nad 2GHz cca 10dB slabša prilagoditev

Fileti:

<http://lea.hamradio.si/~s57uuu/mischam/proto/proto1.pcb> (PCAD)

[http://lea.hamradio.si/~s57uuu/mischam/proto/proto2\\_E.tar](http://lea.hamradio.si/~s57uuu/mischam/proto/proto2_E.tar) (EAGLE)

[http://lea.hamradio.si/~s57uuu/mischam/proto/proto2\\_EG.zip](http://lea.hamradio.si/~s57uuu/mischam/proto/proto2_EG.zip) (Gerbere)

# Preizkusna linija

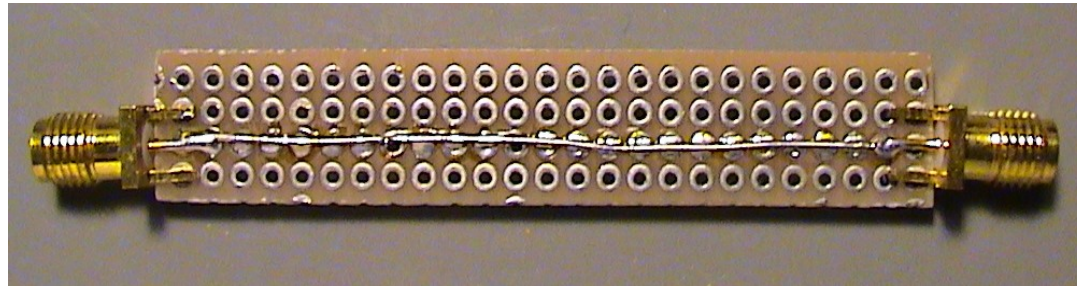

Dolzina = 25 luknjic = 62.5mm

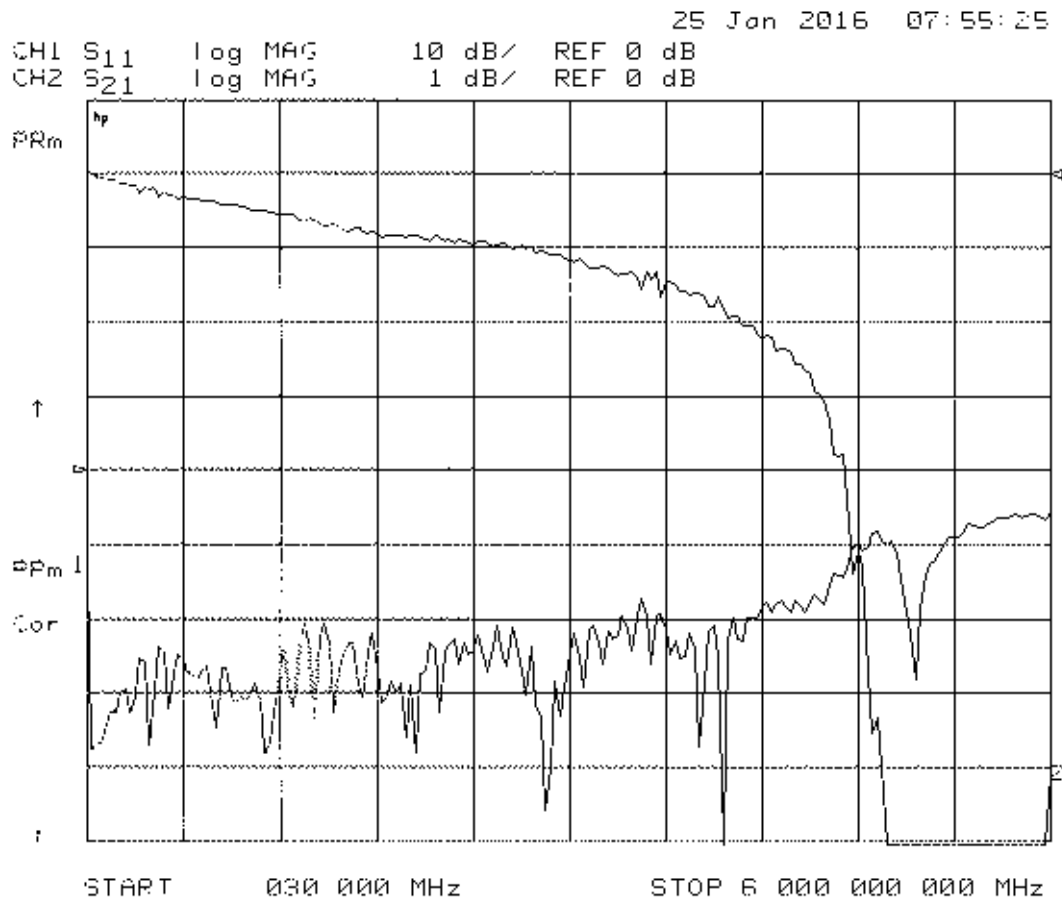

Prilagoditev >20dB do ~4GHz

Izgube:

0.016 dB/cm na 144MHz

0.045 dB/cm na 432MHz

0.08 dB/cm na 1GHz

0.19 dB/cm na 3GHz

0.32 dB/cm na 4GHz

Elektricna dolzina:

180 stopinj pri cca 812MHz

$k = 0.34$  !!!

# Sklopnik?

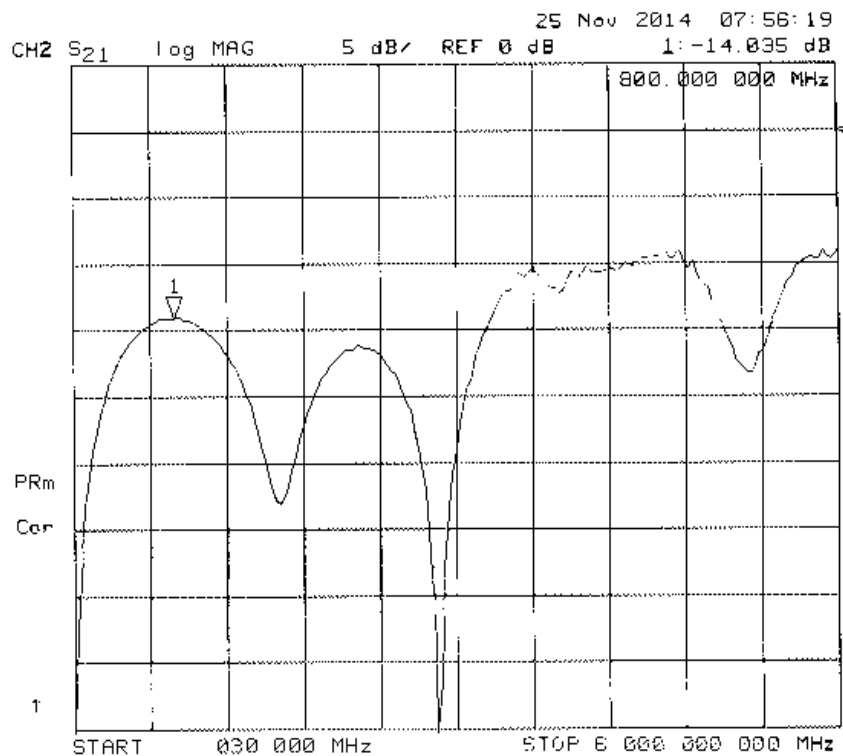
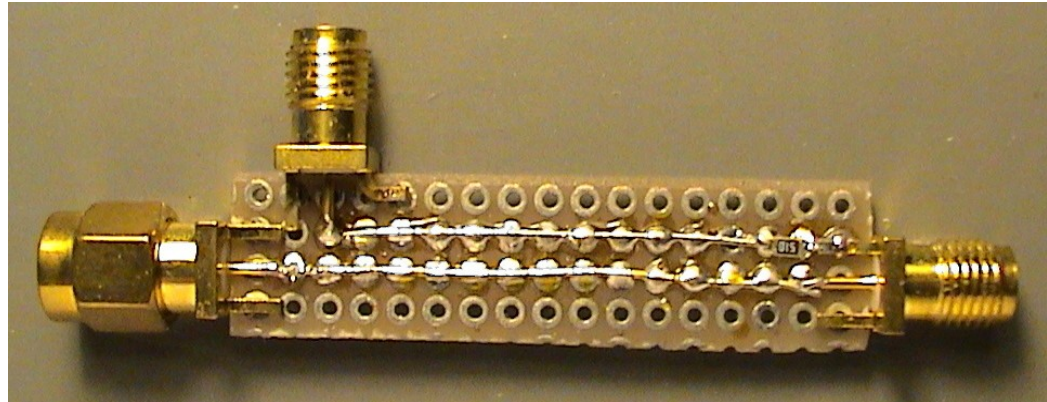

Dolzina = 12 lukenj = 30mm

$\lambda/4$  pri cca 800MHz, sklop 14dB

144MHz	naprej -24dB	nazaj -35dB
432MHz	naprej -16dB	nazaj -26dB
1.3GHz	naprej -18dB	nazaj -15dB

# Visokoprepustno sito, limiter

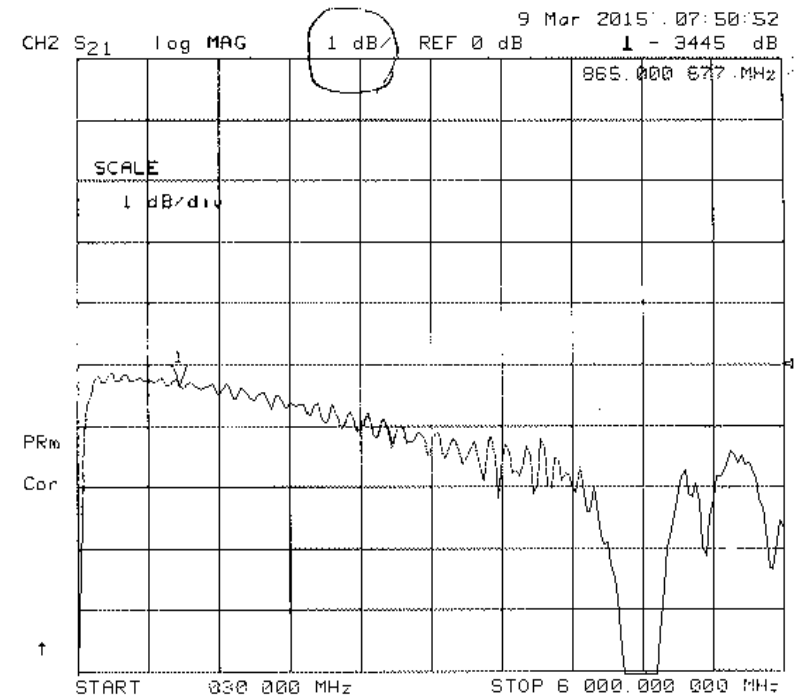
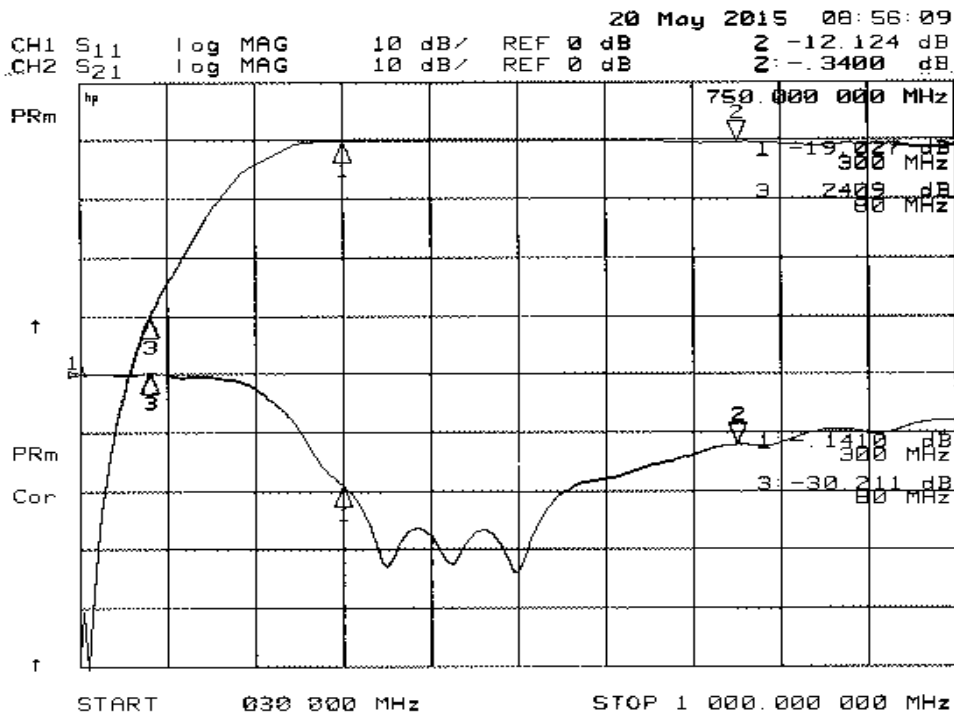
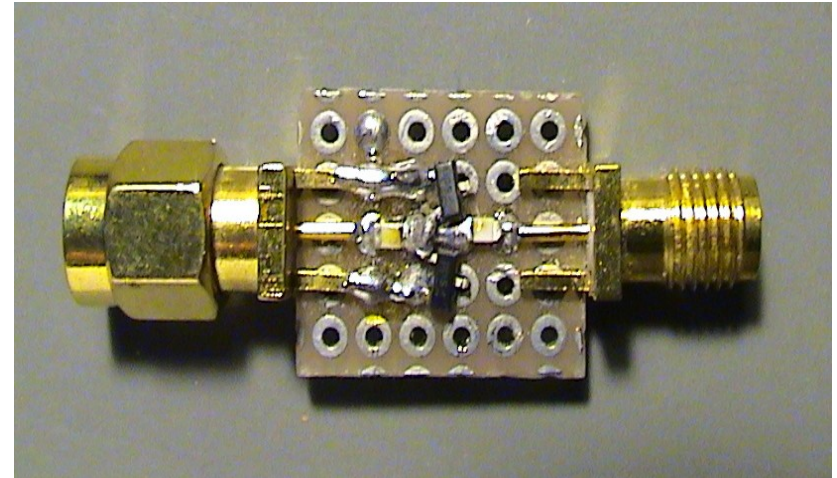
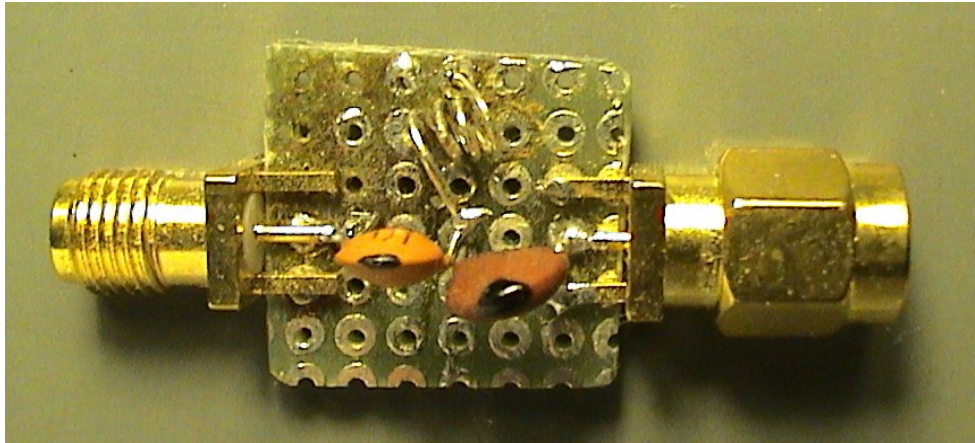

# Ojacevalnik z MSA1120

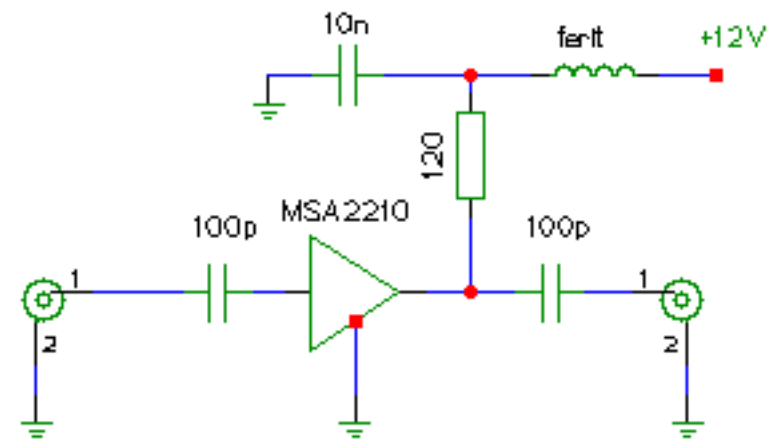
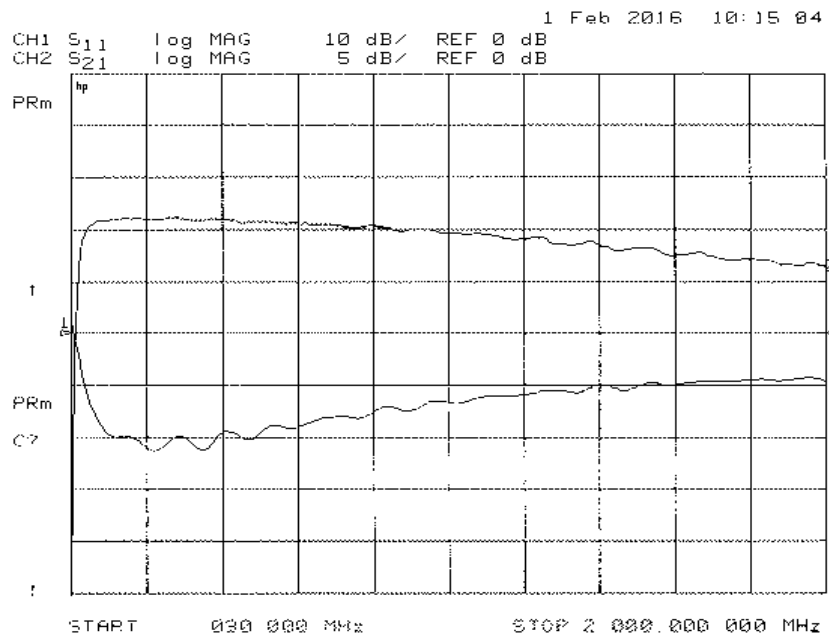
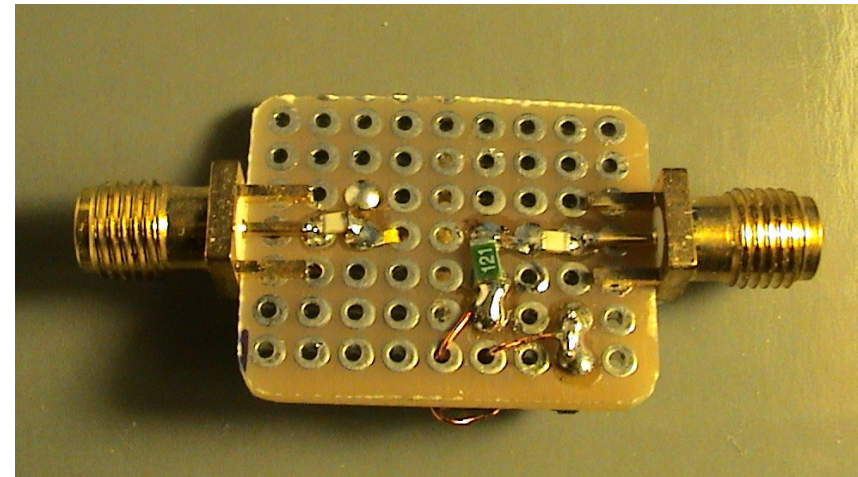
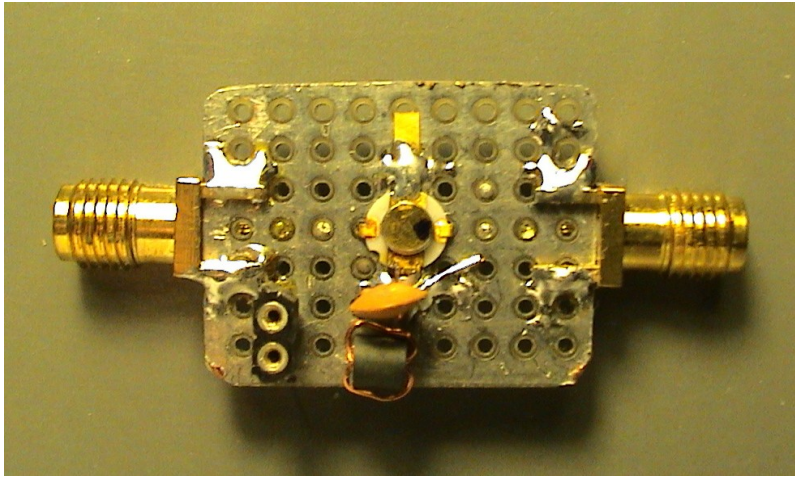

# Ojacevalnik z 2x ERA-2

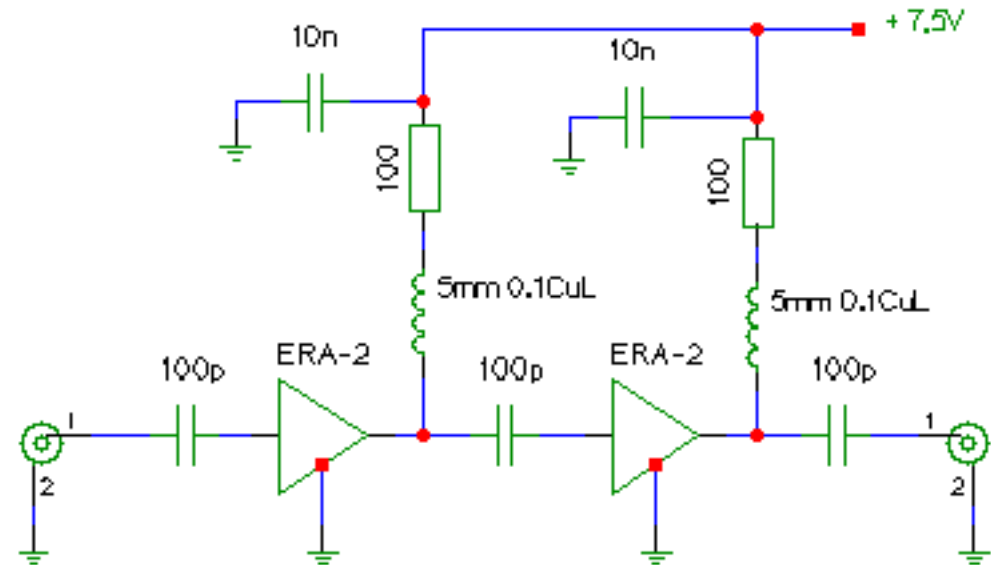
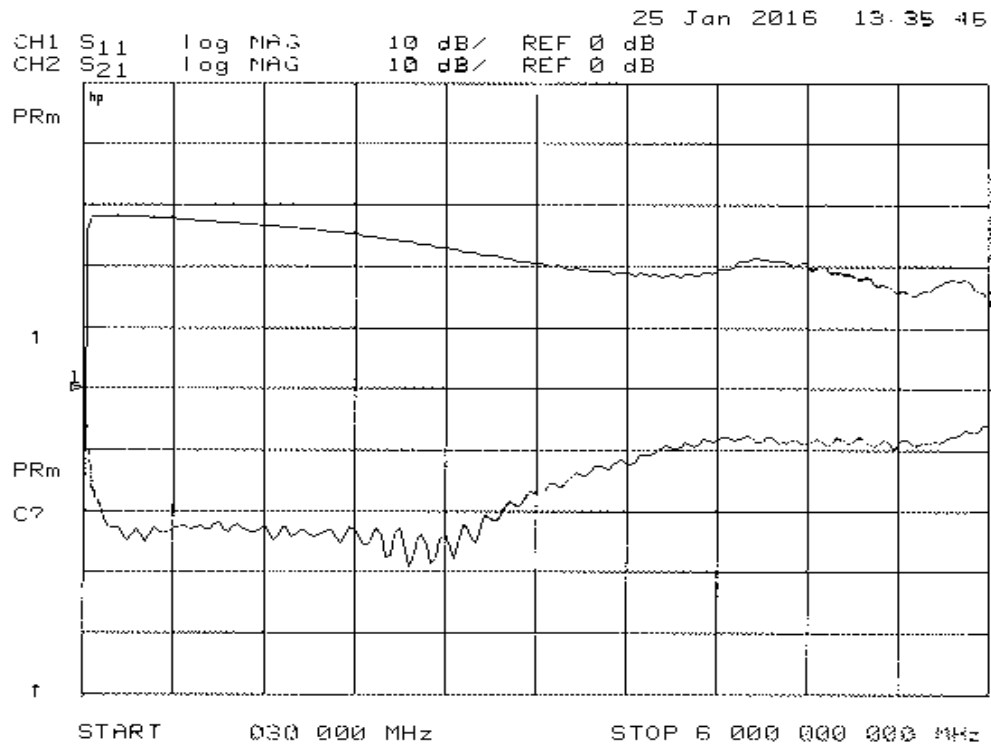
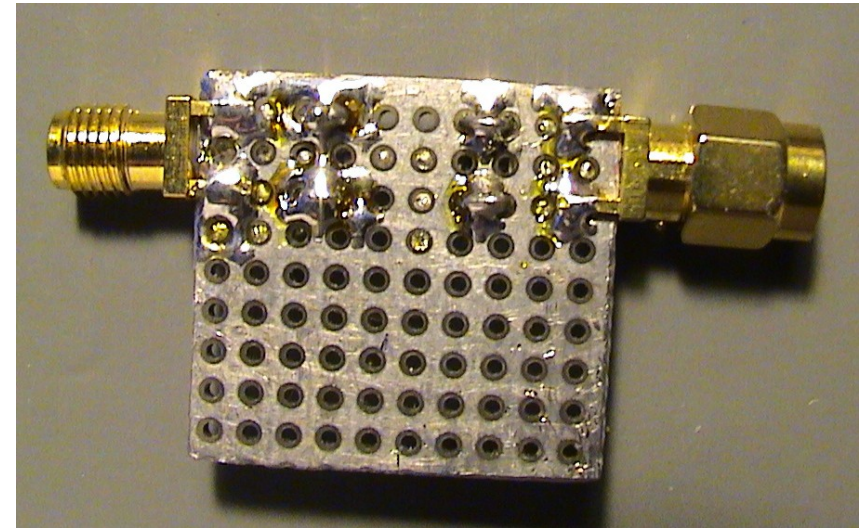
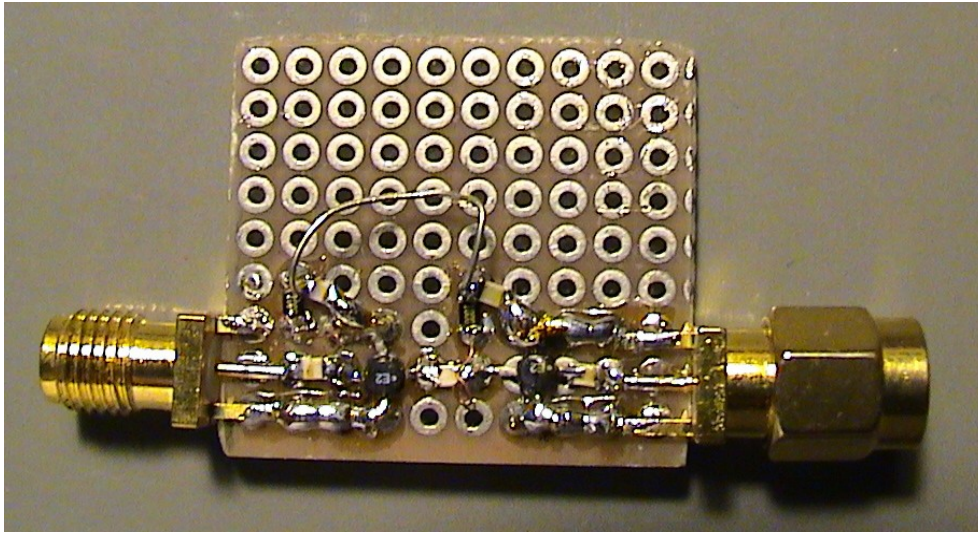

# Montaza SOT363

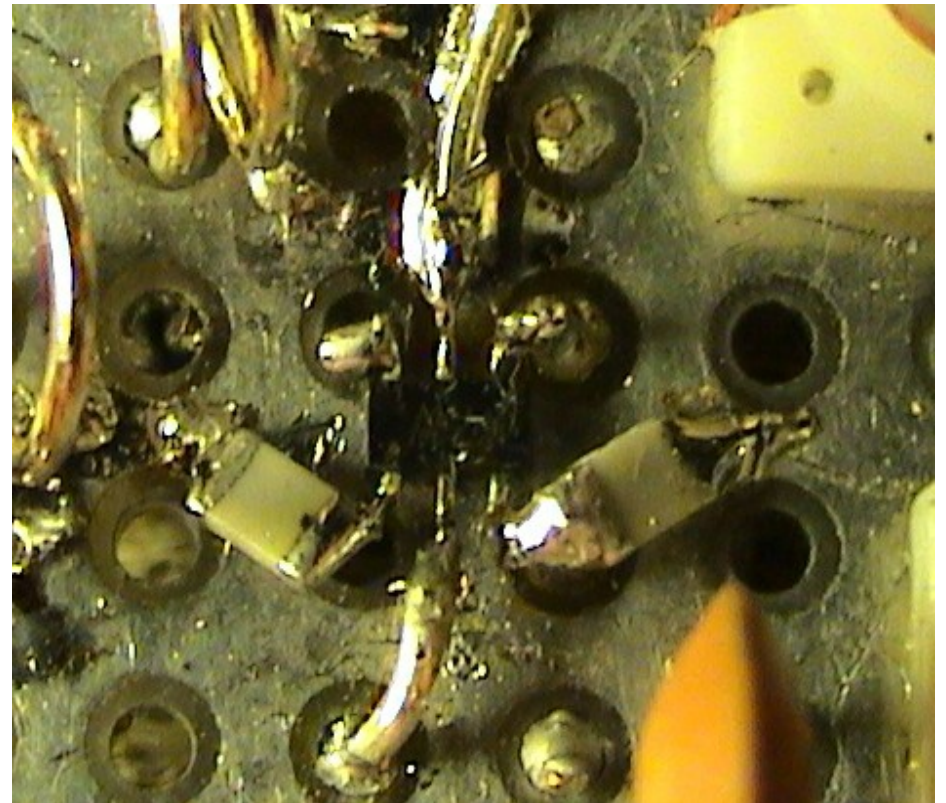
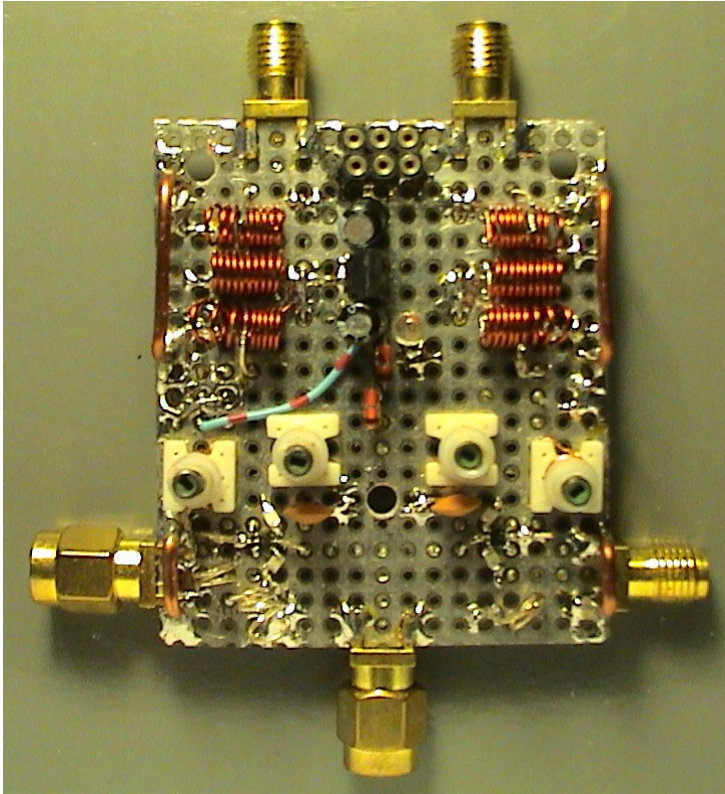

# Pasovno sito

